

## TWO-PHASE MODEL FOR THE STUDY OF BLOOD FLOW THROUGH STENOSED ARTERY

Sapna Ratan Shah\*, S. U. Siddiqui

Department of Mathematics, Harcourt Butler Technological Institute, Kanpur - 208002, (India)

\*Corresponding Author Email: [sapna1980jan@rediffmail.com](mailto:sapna1980jan@rediffmail.com)

**Research Article**

ACCEPTED ON 15-08-2011

RECEIVED ON 25-07-2011

### ABSTRACT

*In this present study the influence of peripheral layer viscosity on physiological characteristics of blood flow through stenosed artery using Power-law fluid model is investigated. The hemodynamics behavior of the blood flow is influenced by the presence of the arterial stenosis. If the stenosis is present in an artery, normal blood flow is disturbed. The non-linear pressure equations have been solved with help of boundary conditions and result are displayed graphically for different flow characteristics. It is found that the resistance to flow decreases as stenosis shape parameter increases and increases as stenosis length, stenosis size, peripheral layer viscosity increases. Comparisons between the measured and computed peripheral layer viscosity profiles are favorable to our solutions. For the validation of numerical model, the computation results are compared with the experimental data and results from published literature.*

**KEYWORDS:** Peripheral layer viscosity, Power-law fluid model, Resistance to flow, Stenosis shape parameter, Wall shear stress

### Introduction

Rheology, the science of the deformation and flow of matter, has become of considerable interest to haematologists, and now the measurement of blood and plasma viscosity is a familiar part of the investigation of vascular disorders and the paraproteinaemias. The term stenosis denotes the narrowing of the artery due to the development of arteriosclerosis plaques or other types of abnormal tissue development. The presence of stenosis can lead to serious circulatory disorders. There is strong evidence that hydrodynamic factors such as resistance to flow, wall shear stress and apparent viscosity may play a vital role in the development and the progression of arterial stenosis. Many researchers<sup>1, 2, 3, 4</sup> feel that the hydrodynamic factors may be helpful in the diagnosis, treatment and fundamental understanding of many disorders. Clark<sup>5</sup> has made experimental

studies with different models of stenosis. However, the models do not account for the size effects due to the suspension of blood cells in plasma. It should be noted that in the case of an advanced stenosis, the size of the artery reduces considerably. In such a case a Newtonian fluid cannot represent blood, because the size effects influence the flow characteristics significantly. With the advent of the fact that rheologic properties and the flow behaviour of blood are of immense importance in the fundamental study of arterial stenosis. Shukla et al.<sup>6</sup> have studied the effect of stenosis on the resistance to flow through artery by considering the behaviour of blood as a power-law fluid and a Casson fluid. Murata<sup>7</sup> has proposed a sedimentation model in which he considered constant values of hematocrit and Newtonian viscosity in the circular core region, containing red cell

aggregates. A theoretical model for sedimentation of red cell aggregates in narrow horizontal tubes have proposed by Secomb and El-Kareh<sup>8</sup> in which they modelled the core region as a solid cylinder moving inside the tube. A little attention<sup>9, 10, 11, 12</sup> has been made to study the effect of stenosis through tubes with double constriction on physiological fluid flows. The present work describes two fluids model for blood flow through an artery. In this study the effects of peripheral layer viscosity

on physiological characteristics of blood through the artery with mild stenosis have been studied. To study the influence of stenosis shape parameter ( $m$ ) through an artery in blood flow a suitable geometry is considered such that the axial shape of the stenosis can be changed just by varying a parameter. In this model the suspension of erythrocytes in the core region is assumed to be non-Newtonian fluid and peripheral plasma layer is treated as Newtonian fluid<sup>13</sup>.

### Analysis of the problem

Consider the axisymmetric flow of blood in a uniform circular tube with an axially non-symmetric but radially symmetric mild stenosis. The geometry of the stenosis as shown in (Fig.1) is assumed to be manifested as:

$$\frac{R(z)}{R_0} = 1 - A[L_0^{(m-1)}(z-d) - (z-d)^m], \quad d \leq z \leq d + L_0$$

$$= 1, \quad \text{otherwise,} \quad (1)$$

where  $R(z)$  and  $R_0$  is the radius of the capillary with and without stenosis, respectively.  $L_0$  is the stenosis length and  $d$  indicates its location,  $m \geq 2$  is a parameter determining the stenosis shape and is referred to as shape parameter. Axially symmetric stenosis occurs when  $m = 2$ , and a parameter  $A$  is given by:

$$A = \frac{\delta}{R_0 L_0^m} \frac{m^{m/(m-1)}}{(m-1)}$$

Where,  $\delta$  denotes the maximum height of stenosis at  $z=d+L_0/m^{1/(m-1)}$ .  $\delta/R_0 \ll 1$

The function  $R_1(z)$  representing the shape of the central layer assumed as,

$$\frac{R_1(z)}{R_0} = \alpha - A_1[L_0^{(m-1)}(z-d) - (z-d)^m], \quad d \leq z \leq d + L_0$$

$$= \alpha, \quad \text{otherwise,} \quad (2)$$

$$A_1 = \frac{\delta_1}{R_0 L_0^m} \frac{m^{m/(m-1)}}{(m-1)}$$

Where,  $\delta_1$  denotes the maximum bulging of interface at  $z = d + L_0/m^{1/(m-1)}$  due to the presence of stenosis and  $\alpha$  is the ratio of the central core radius to the tube radius in the unobstructed region.



Figure: 1 Atherosclerosis

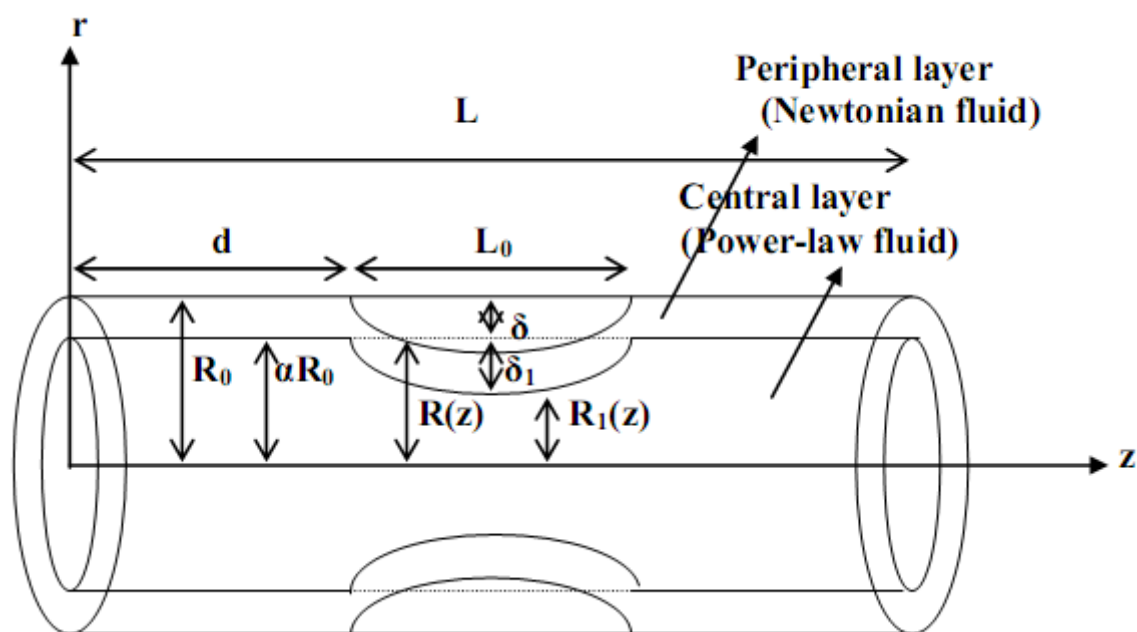

Figure-a : Geometry of stenosed artery with peripheral layer

### Conservation equation and boundary condition

The equation of motion for laminar and incompressible, steady, fully developed, one-dimensional flow of blood whose viscosity varies along the radial direction in a capillary is:

$$\left(-\frac{dP}{dz}\right) + \frac{1}{r} \frac{\partial}{\partial r} [r \mu (\partial u / \partial r)] = 0, \quad (3)$$

where (z, r) are (axial, radial) co-ordinates with z measured along the axis and r measured normal to the axis of the capillary.

Following boundary conditions are introduced to solve the above equations,

$$\begin{aligned} \frac{\partial u}{\partial r} &= 0 & \text{at } r = 0, & & u &= 0 & \text{at } r = R(z), \\ P &= P_0 & \text{at } z = 0, & & P &= P_L & \text{at } z = L, \\ \tau &\text{ is finite} & \text{at } r = 0. & & & & \end{aligned} \tag{4}$$

To see the effect of peripheral layer viscosity on the stenosis shape parameter, resistance to flow, shear stress and apparent viscosity, we consider the viscosity function as follows:

$$\begin{aligned} \mu &= \mu_1, & 0 \leq r \leq R_1(z), \\ \mu &= \mu_2, & R_1(z) \leq r \leq R(z), \end{aligned} \tag{5}$$

Where  $\mu_1$  and  $\mu_2$  are the viscosities of the central and the peripheral layers respectively.

Power-law fluid: Non-Newtonian fluid is that of power-law fluid which have constitutive equation,

$$\left. \begin{aligned} \left( -\frac{du}{dr} \right) &= \left( \frac{\tau}{\mu} \right)^{1/n} = f(\tau), \\ \text{where } \tau &= \left( -\frac{dp}{dz} \right) \frac{R_c}{2} \end{aligned} \right\} \tag{6}$$

Where  $u$  is the axial velocity,  $\mu$  is the viscosity of fluid,  $(-dp/dz)$  is the pressure gradient and  $n$  is the flow behaviour index of the fluid.

### Solution of the problem

The flow flux  $Q$ , at any cross section is defined as

$$Q = \int_0^{R(z)} 2\pi r u dr = \int_0^{R(z)} \pi r^2 \left( -\frac{du}{dr} \right) dr, \tag{7}$$

on using equation (3, 6) and boundary condition (4), we get

$$Q_1 = \int_0^{R_1(z)} \pi r^2 \left( -\frac{du}{dr} \right) dr = (\pi P R_1^4(z) / 8\mu_1) \tag{8}$$

$$Q_2 = \int_{R_1(z)}^{R(z)} \pi r^2 \left( -\frac{du}{dr} \right) dr = \frac{\pi P}{8\mu_2} [R^4(z) - R_1^4(z)] \tag{9}$$

The total flux,  $Q$  is

$$Q = Q_1 + Q_2$$

and  $Q$  is written as;

$$Q = \frac{\pi P}{8 \mu_2} [R^4(z) - (1-\pi)R_1^4(z)] \quad (10)$$

where  $\mu = \frac{\mu_2}{\mu_1}$ ,

From equation (10) the pressure gradient is written as follows:

$$P = (8\mu_2 Q / \pi [R^4(z) - (1-\mu) R_1^4(z)]) \quad (11)$$

To determine  $\lambda$ , we integrate equation (11) for the pressure  $P_L$  and  $P_0$  which are the pressures at  $z=0$  and  $z=L$ , respectively, where  $L$  is the length of the tube.

The resistance to flow is defined as follows:

$$\lambda_0 = (P_L - P_0 / Q) \quad (12)$$

Let  $\lambda_N$  is the resistance to flow for Newtonian fluid with no stenosis, then

$$\lambda_N = (8 \mu_1 L / \pi R_0^4) \quad (13)$$

From equation (12) and (13) we have,

$$\lambda = \frac{\lambda_0}{\lambda_N} = 1 - \frac{L_0}{L} + \frac{(1-(1-\mu)\alpha^4)}{L} \int_0^L (dz / [(\frac{R(z)}{R_0})^4 - (1-\mu) (\frac{R_1(z)}{R_0})^4]) \quad (14)$$

Equation (12) can be rewritten as:

$$Q = (\pi P R^4 / 8 \mu_{app})$$

Where  $\mu_{app}$  is the apparent total tube flow viscosity given by:

$$\mu_{app} = \frac{\mu}{[1-(1-\mu)\alpha^4]} \frac{1}{(R(z)/R_0)^4} \quad (15)$$

The shearing stress at the maximum height of the stenosis can be written as:

$$\tau_s = (4\mu_2 Q (1 - \frac{\delta}{R_0}) / \pi R_0^3 [(1 - \frac{\delta}{R_0})^4 - (1-\mu) (\alpha - \frac{\delta}{R_0})^4]) \quad (16)$$

and the shear stress for Newtonian fluid with no stenosis is as:

$$\tau_N = (4 \mu_1 Q / \pi R_0^3) \quad (17)$$

now the ratio of shearing stresses at the wall can be written as:

$$\tau = (\tau_S / \tau_N) = (\mu / [1 - (1 - \mu)\alpha^4]) (1 - \frac{\delta}{R_0})^3 \quad (18)$$

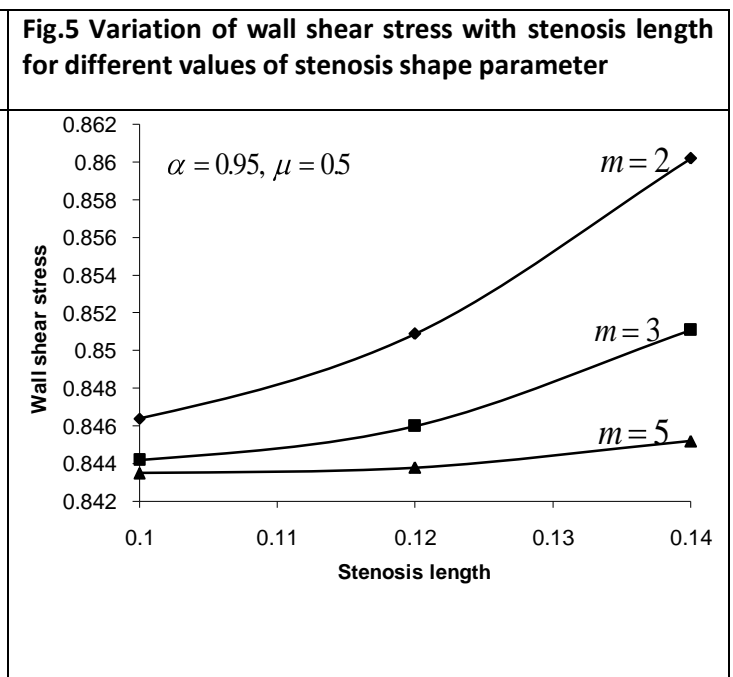
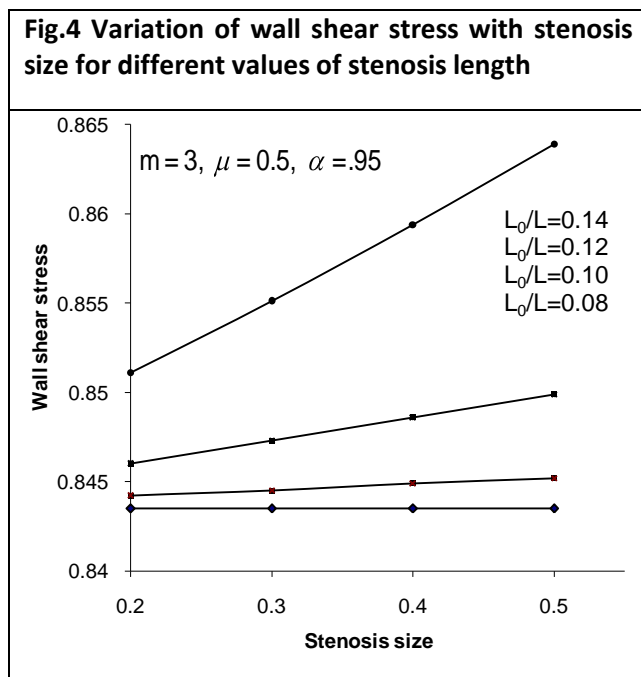
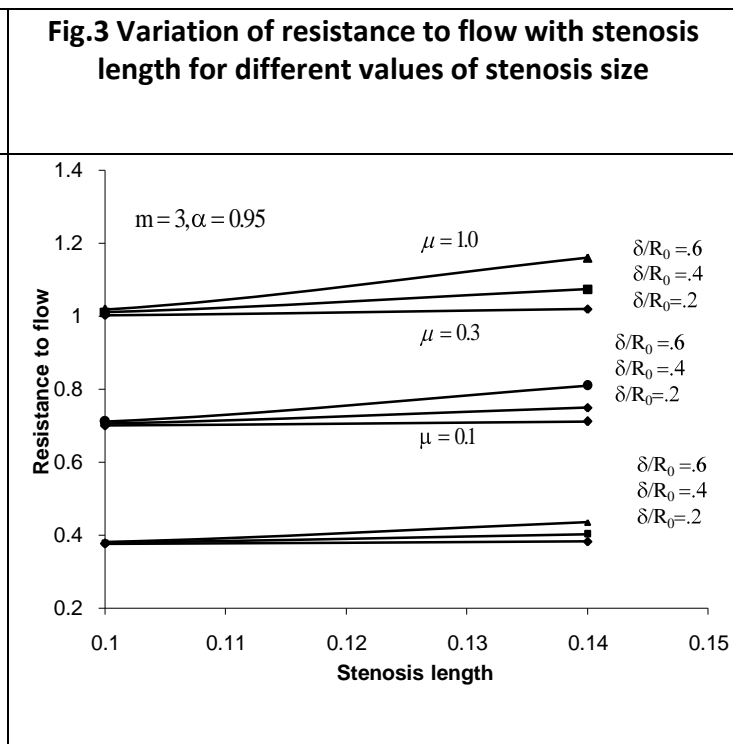
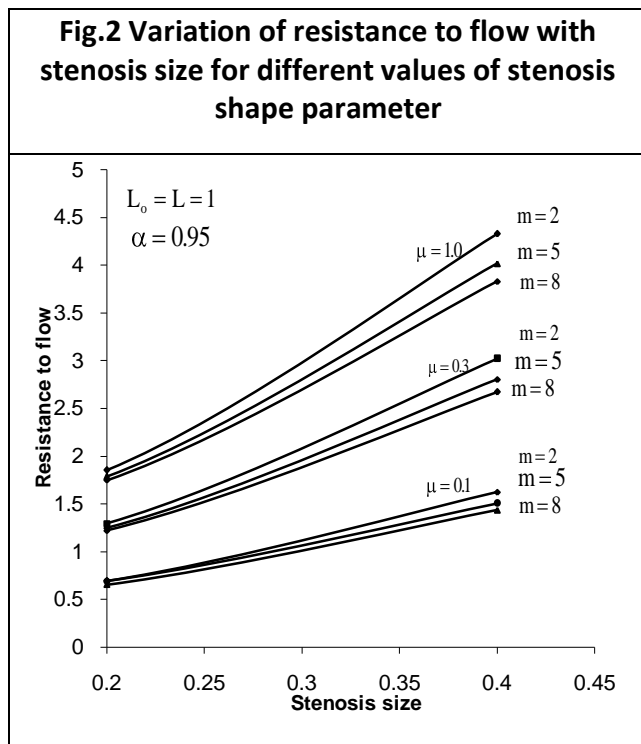

## Results and discussion

The model presented above contributes to the fact that blood possesses an inbuilt mechanics of reducing drag due to the presence of peripheral layer. Therefore incorporation of a cell free layer of plasma and a central core of thickly concentrated suspension of cells with higher viscosity ( $\mu_2 > \mu_1$ ) describes the simplest representation of blood in small diameter vessels. The results obtained in this study consist of the expression for resistance to flow ( $\lambda$ ) in equation (14), expression for apparent viscosity ( $\mu_{app}$ ) in equation (15) and expression for shear stress in equation (18) and displayed graphically. **Fig (2) and (3)** depict the variation of resistance to flow with stenosis size, stenosis length, stenosis shape parameter and peripheral layer viscosity. It is observed from the figures that the resistance to flow decreases as stenosis shape parameter increases while it increases as stenosis size and peripheral layer viscosity increases. A slight change in the stenosis size (radius of the

artery) brings about a noticeable change in the resistance to flow<sup>4</sup>. It is found by<sup>15</sup> that the peripheral layer viscosity of blood in diabetic patients is higher than in non-diabetic patients, resulting higher resistance to blood flow. Thus diabetic patients with higher peripheral layer viscosity are more prone to high blood pressure. Therefore the resistance to blood flow in case of diabetic patients may be reduced by reducing viscosity of the plasma. This can be done by injecting saline water to such patients the process is called dilution in medical terms. **Fig (4) and (5)** consist the results for wall shear stress for different values of stenosis size and stenosis length, stenosis shape parameter and peripheral layer viscosity. It is observed from the figures that the wall shear stress decreases as stenosis shape parameter increases but in the case of increasing stenosis size, stenosis length and peripheral layer viscosity wall shear stress is increasing.

**Fig.6 Variation of apparent viscosity with stenosis size different values of peripheral layer viscosity**

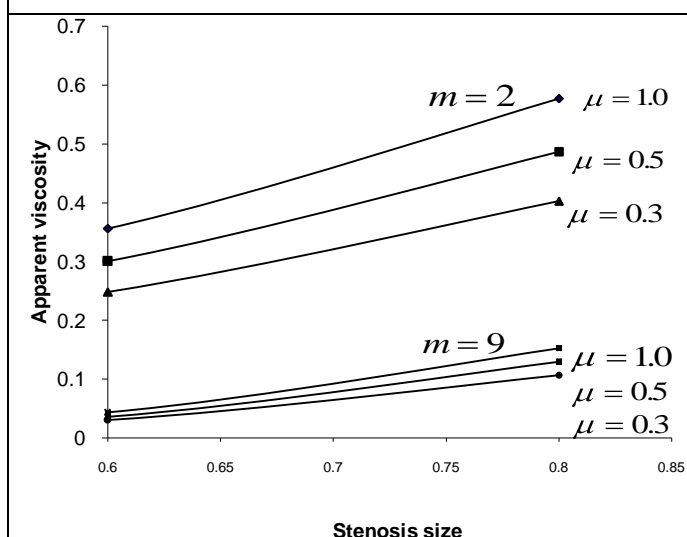

**Fig.7 Variation of apparent viscosity with stenosis length for values of Peripheral layer viscosity**

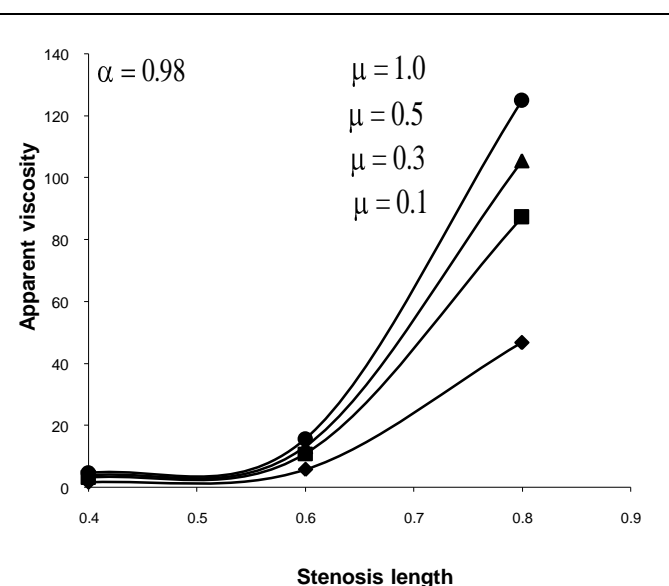

**Fig (6) and Fig (7)** highlighted the results for apparent viscosity with the variation of stenosis size, stenosis length, stenosis shape parameter and peripheral layer viscosity. These figures depict that apparent viscosity increases as stenosis size, stenosis length and peripheral layer viscosity increases. It has also been seen from the graphs that the apparent viscosity decreases as shape parameter increases. These results are qualitative agreement with the observation of <sup>14, 18</sup>. In normal human artery, apparent viscosity is found to decrease with the artery radius and is called Fahraeus-Lindquist effect. One may conclude that peripheral layer viscosity plays an important role in lowering the resistance to flow and wall shear stress along the increasing stenosis thickness. In medical practice several medicines are prescribed to lower the plasma viscosity and by injecting saline water intravenously <sup>16,17</sup>.

**Concluding remarks:** The effect of peripheral layer viscosity on the blood flow in the presence of mild stenosis in the lumen of the artery has been investigated by using Power law fluid model. It has concluded that the resistance to flow, apparent viscosity and wall shear stress have been found to increase with viscosity of peripheral layer but the same are not found to increase as the shape of stenosis increases. The model predicts increase in wall shear stress with peripheral layer viscosity. Predicted trends are found to exist in artery and hence validate the model. More experimental results are required for further development from clinical point of view.

**Acknowledgement:**

Authors gratefully acknowledge the financial assistance from the UGC major research project No.37-493/2009(SR) for this work.

**References:**

- 1 Young D. F. (1968): Effects of a time-dependent stenosis on flow through a tube. J. Engg. India, Trans. ASME, vol.90, pp.248-254.
- 2 Caro C. G. (1981): Arterial fluid mechanics and atherogenesis. - Recent advances in cardiovascular diseases (supplement), vol.2, pp.6-11.
- 3 Shukla J. B., Parihar R. S. and Rao B. R. P. (1980): Effects of stenosis on non-Newtonian flow of blood in an artery. - Bulletin of Mathematical Biology, vol. 42, pp.283-294.
- 4 Haldar K. (1985): Effects of the shape of stenosis on the resistance to blood flow through an arter. Bulletin of Mathe. Bio., vol.47, pp.545-550.
- 5 Clark C. (1976): The fluid mechanics of aortic stenosis- Unsteady flow experiments. J. Biomech, vol.9, pp.567-573.
- 6 Shukla J. B., Parihar R. S. and Rao B. R. P. (1980): Effects of stenosis on non-Newtonian flow of blood in an artery. - Bulletin of Mathematical Biology, vol. 42, pp.283-294.
- 7 Murata, T. (1998) Theoretical analysis of flow properties of aggregating red cell suspensions in narrow horizontal tubes, Clini. Hemorrh., 14, 519-530.
- 8 Secomb T.; El-Kareh. (2002) A model for motion and sedimentation of cylindrical red cell aggregation during slow blood flow in narrow tubes, Biomech. Eng. , 116, 243-249.
- 9 Chaturani P. and Samy R. P. (1986): Pulsatile flow of Casson's fluid through



- stenosed arteries with application to blood flow. *Biorhe.*, vol.23, pp.499-511.
- 10 Lee T. S. (1990): Numerical studies of fluid flow through tubes with double constrictions. *I J Numer. Methods Fluids*, vol.11, pp. 1113-1126.
  - 11 Misra J. C., Patra, M. K. and Misra S. C. (1993): A non-Newtonian model for blood flow through arteries under stenotic conditions, *J. Biomech*, vol. 26, pp.1129-1141.
  - 12 Tandon P. N. and Rana U. V. S. (1995): A new model for blood flow through an artery with axisymmetric Stenosis, *I. J. Biomed. Comput*, vol.38, pp.257-267.
  - 13 Cabel, M.; Meiselman, H. J.; Popel, A. S.; Johnson, P. C. (1999) Contribution of red blood cell aggregation to venous in skeletal muscle, *Amer. J. Phy.*, 272, 1020-1032.
  - 14 Lerche, D. (2009) Modeling hemodynamics in small tubes (hollow fibers) considering non-Newtonian blood properties and radial hematocrit distribution. In: *Biomechanical Transport Processes*, Mosora F., Eds., New York, Plenum; 243-250.
  - 15 Chakravarty S., Mandal P.K. (2001): Two-dimensional blood flow through tapered arteries under stenotic conditions *Int. J. Non-Linear Mechanics*. vol 36. P. 731-741.
  - 16 Pontrelly G, (2007): Blood flow through an axisymmetric stenosis, *Proc. Inst. Mech. Eng J. in Medicine* Vol. 215, 1-10.
  - 17 [Shalmanab](#), E, [Rosenfelda](#), M., [Dganyb](#), E, and [Einava](#), S, (2002) "Numerical modeling of the flow in stenosed coronary artery. The relationship between main hemodynamic parameters" 12, 589-602.
  - 18 Sankar, D. S. and Hemalatha, K., (2008) "Pulsatile flow of Herschel-Bulkey fluid through stenosed arteries- A Mathematical model", *Inter. J. Non-linear Mech.* 41, 979-990.



**\*Address for the Correspondence:**

**Sapna Ratan Shah\***

*Department of Mathematics, Harcourt Butler  
Technological Institute, Kanpur - 208002,  
(India)*

*Fax No. 0512-2533812*

*E.mail: [sapna1980jan@rediffmail.com](mailto:sapna1980jan@rediffmail.com)*